



BeClever



Catalogue
Katalog
Katalog



BeClever

BC 16 S U



BC 20 S U



BC 24 S U



BC 16 S C



BC 20 S C

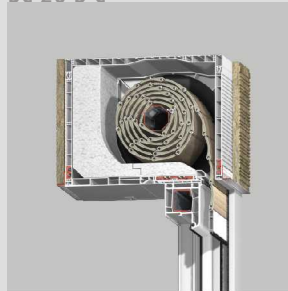

BC 24 S C



BC 16 | U

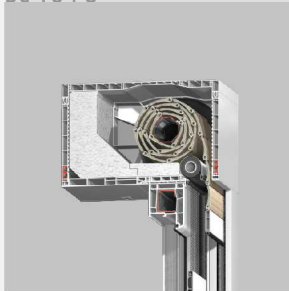

BC 20 | U



BC 24 | U



BC 16 | C

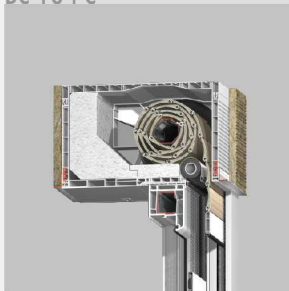

BC 20 | C

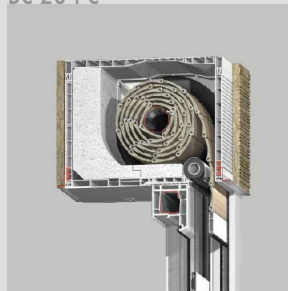

BC 24 | C



an innovative system of on-window rollshutters
innovatives Fensterrollladensystem
innowacyjny system rolet naokiennych

BC 24 | C

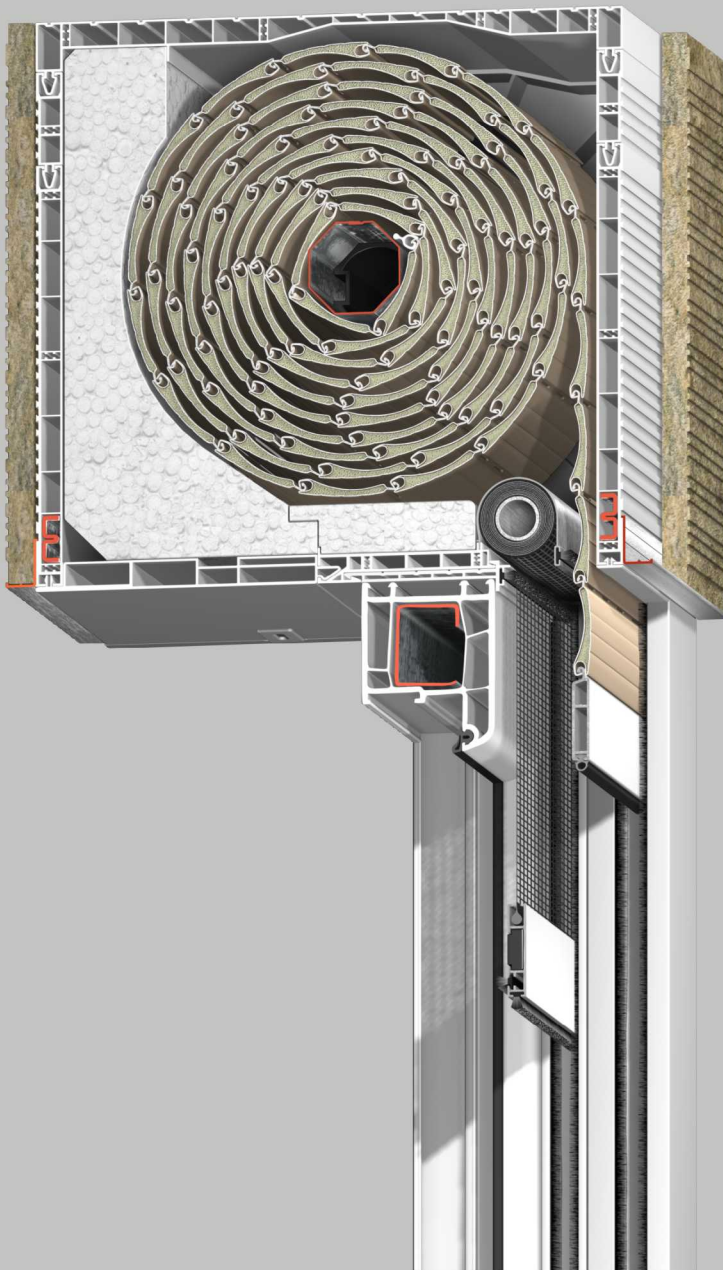

www.beclever.eu



BeClever

BC 16/20/24 S

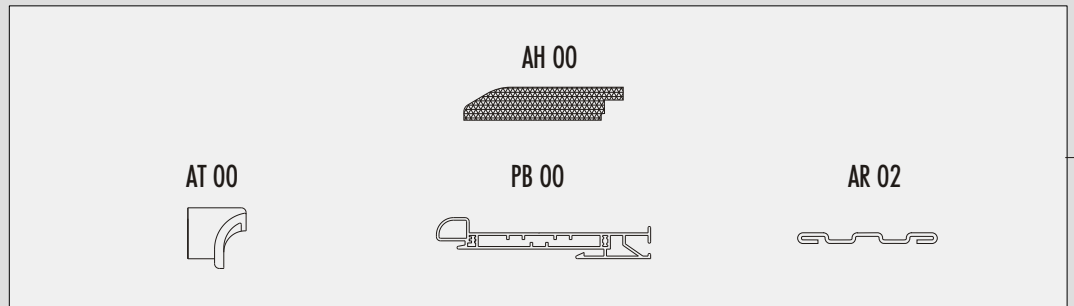

BC 16/20/24 I

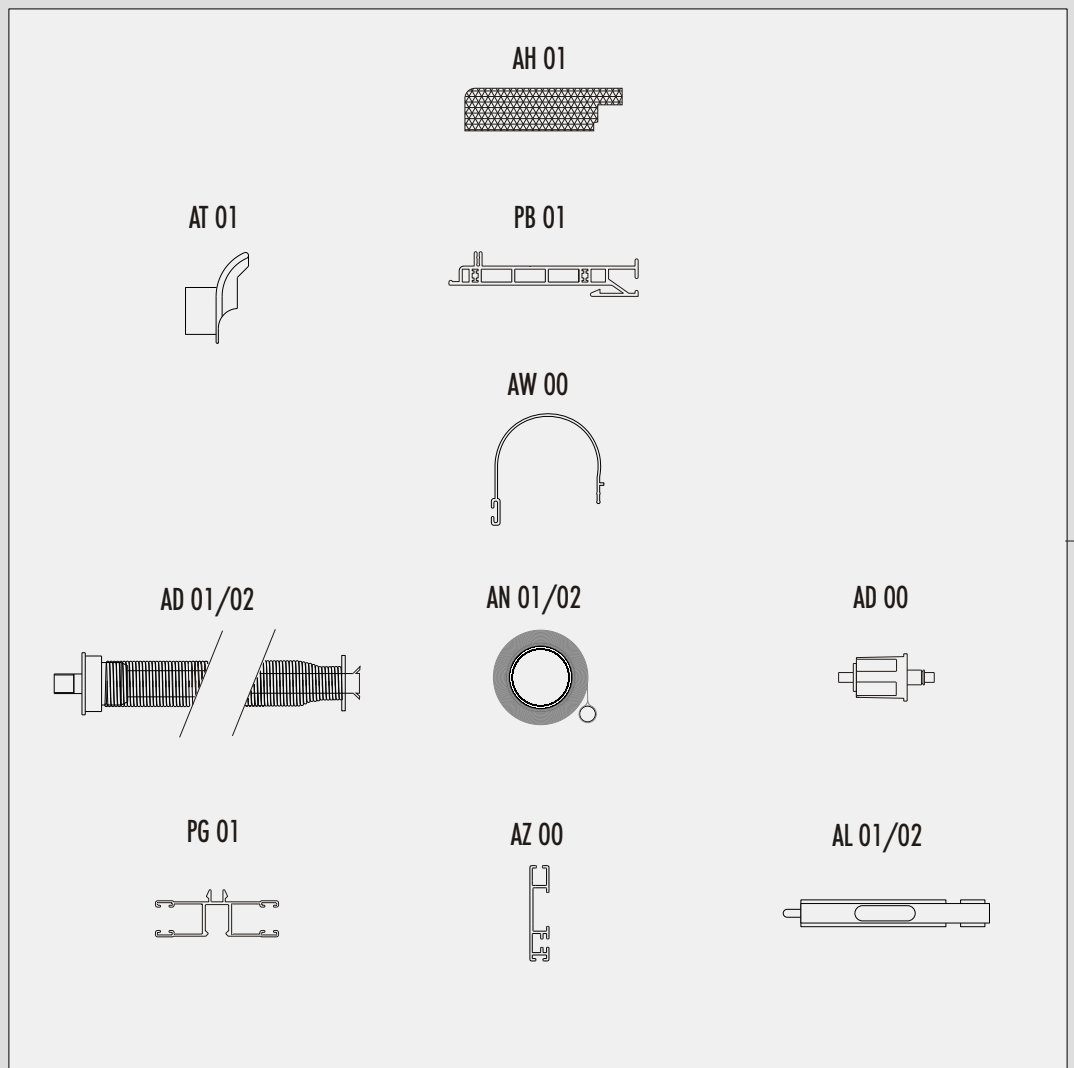

one element - many applications
 ein Element - viele Verwendungsmöglichkeiten
 jeden element - wiele zastosowań

BC 16/20/24 S
 BC 16/20/24 I

BC 16/20/24 S

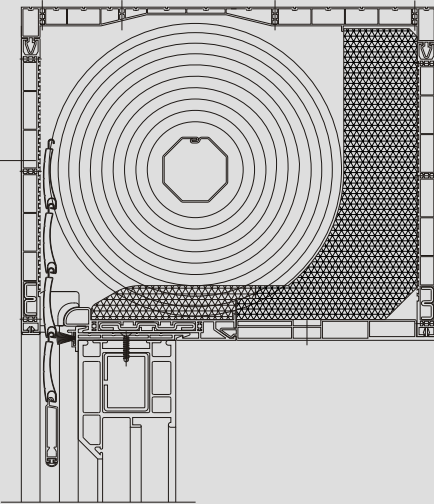

BC 16/20/24 I

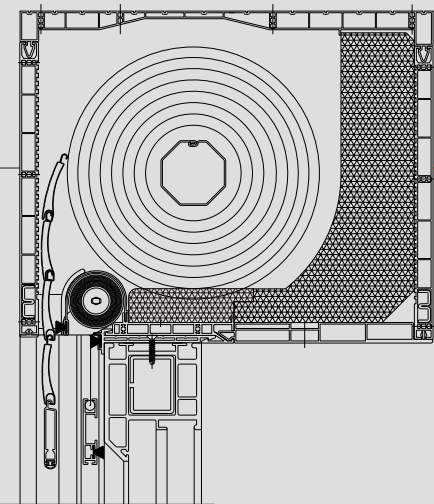

PT 00



PF 10/20/30



AE 10/20/30

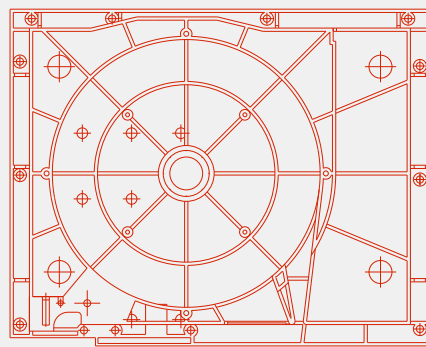

AH 10/20/30

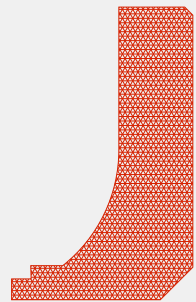

AU 00



PC 00



PA 00



PG 00

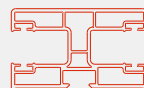

AR 01





BeClever

BC 16/20/24 S

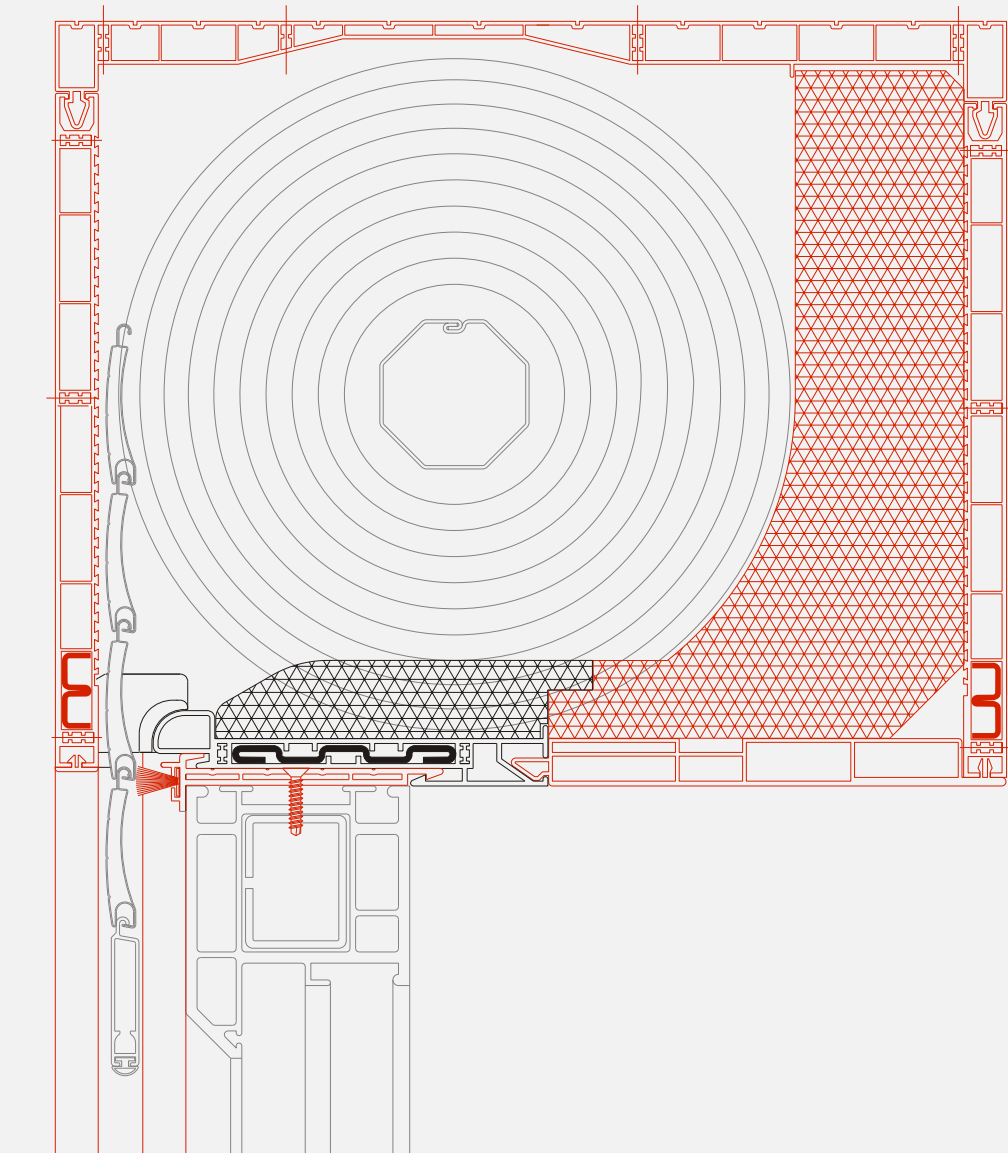

one element - many applications
ein Element - viele Verwendungsmöglichkeiten
jeden element - viele zastosowań

BC 16/20/24 |

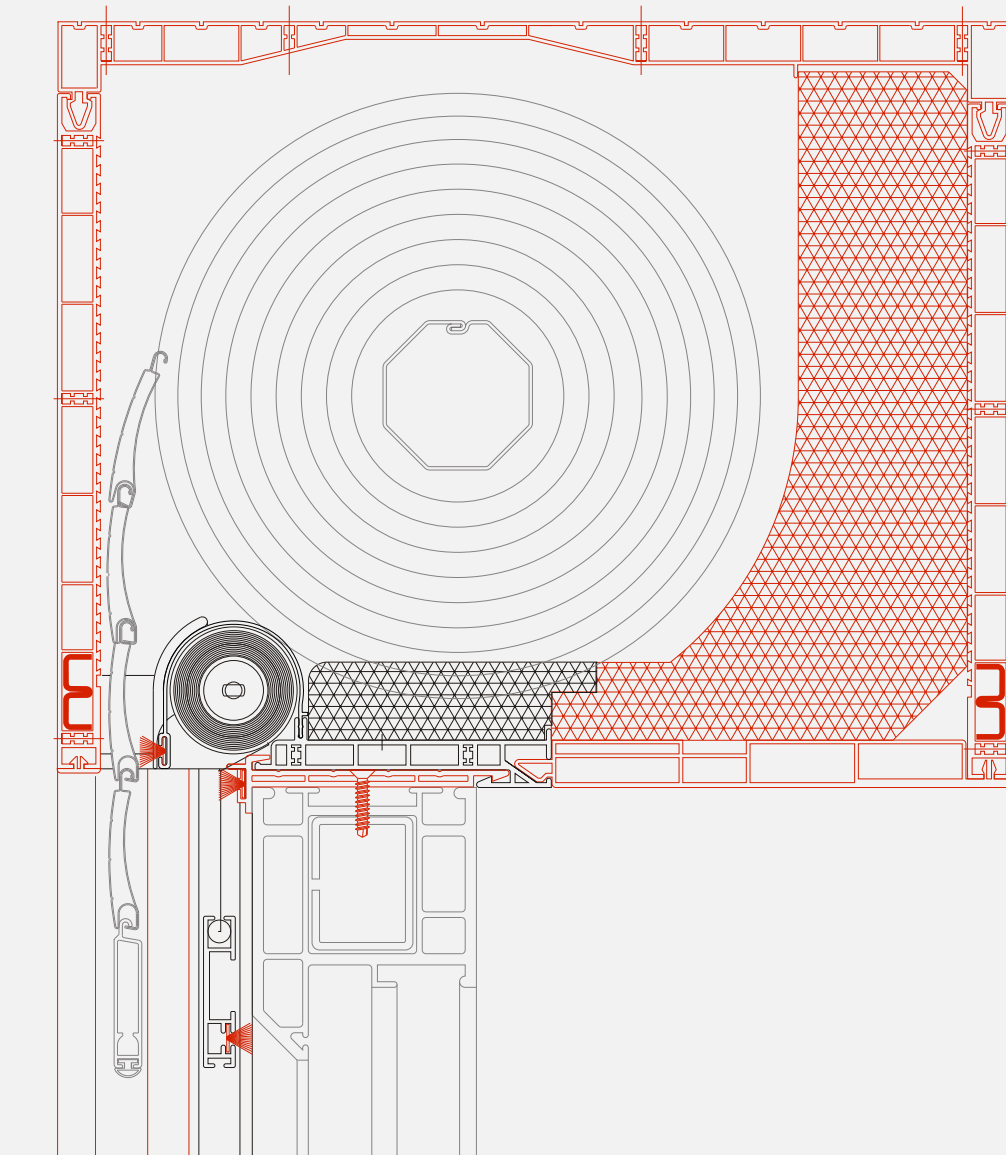



BeClever

BC 16 S

BC 16 S U

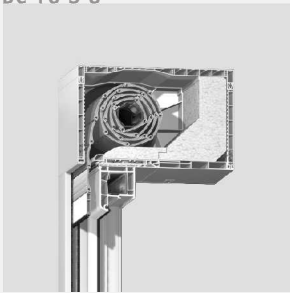

BC 16 S C(R)

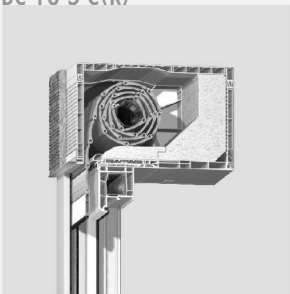

BC 16 S C(F)

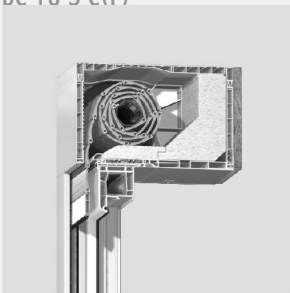

BC 16 S C

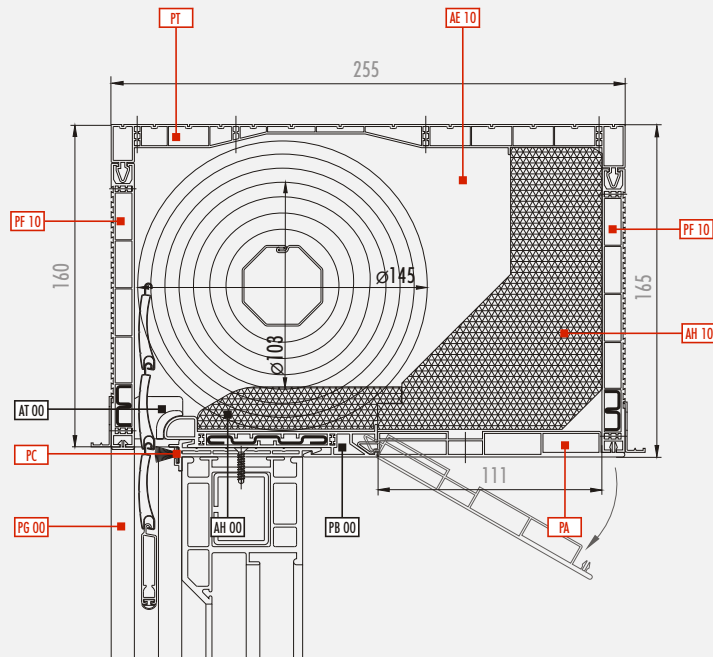
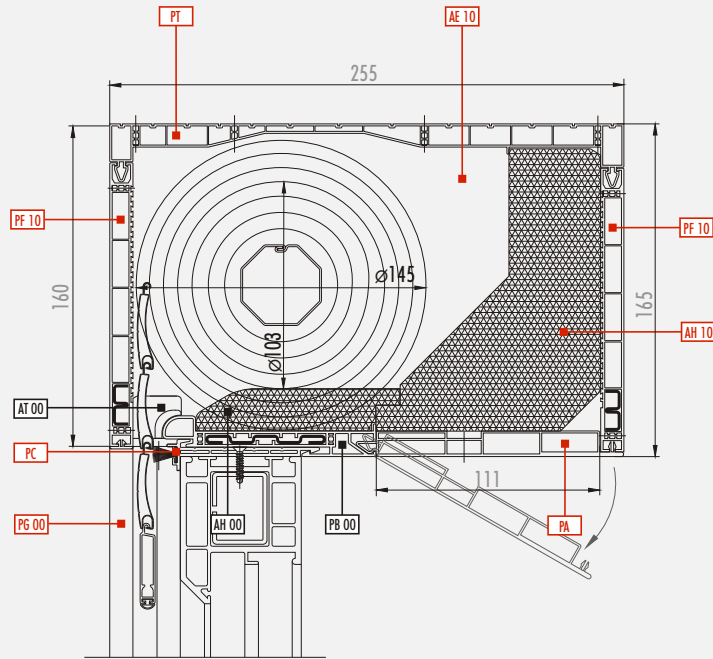
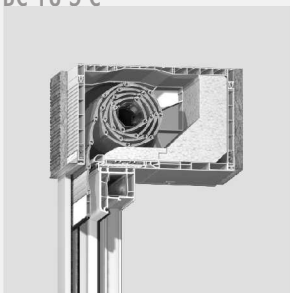

BC 16 S U

Uncovered 160mm box in standard version

Standardrollladenkasten 160mm ohne Einbau

Skrzynka 160mm w wersji standardowej bez zabudowy

BC 16 S C

Covered 160mm box in standard version

Standardeinbaurollladenkasten 160mm

Skrzynka 160mm w wersji standardowej do zabudowy całkowitej

one element - many applications
 ein Element - viele Verwendungsmöglichkeiten
 jeden element - viele zastosowań

BC 16 I

BC 16 I U

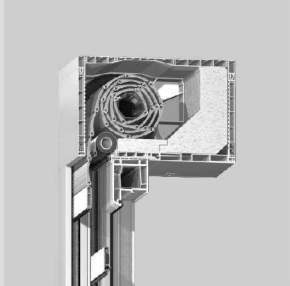

BC 16 I C(R)

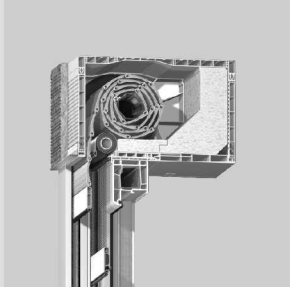

BC 16 I C(F)

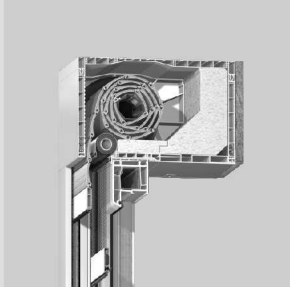

BC 16 I C

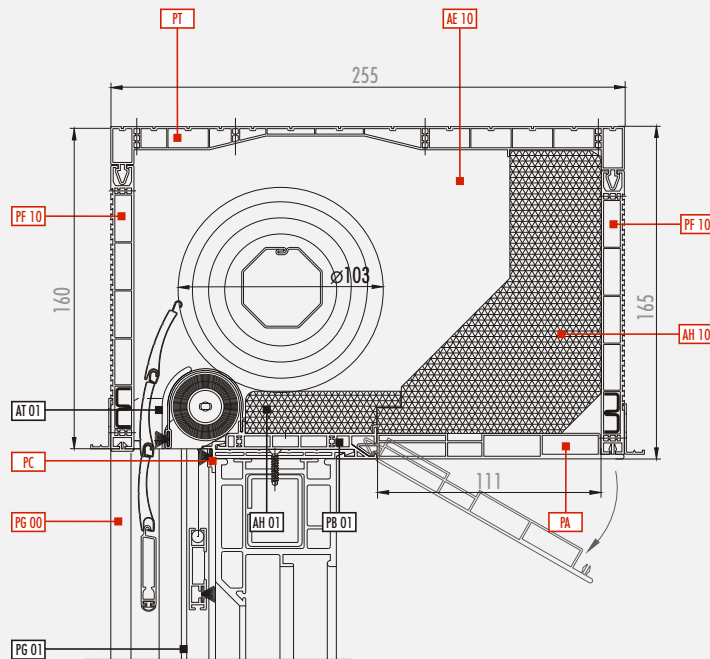
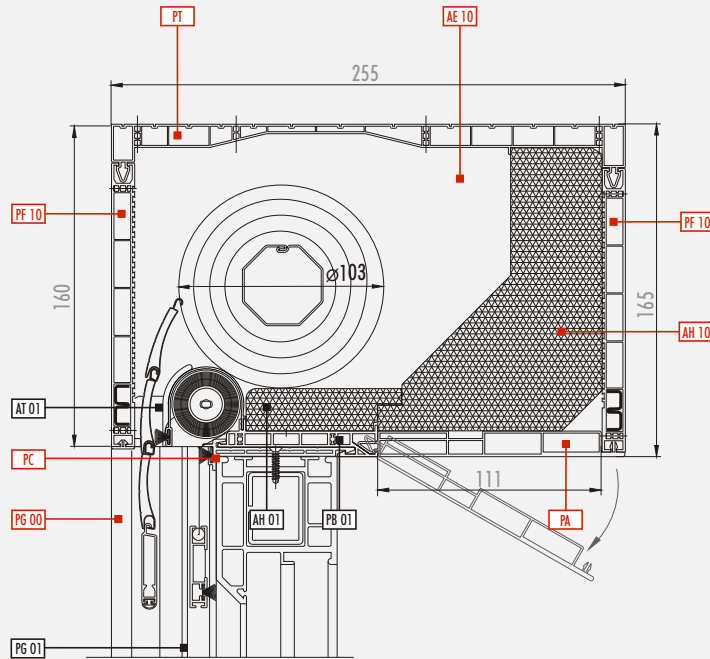
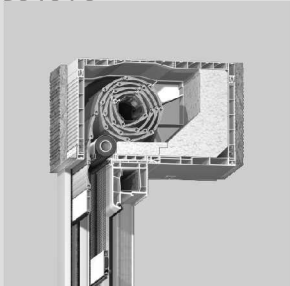

BC 16 I U

Uncovered 160mm
 box in insect screen version

Rollladenkasten 160mm
 mit Insektenschutz
 ohne Einbau

Skrzynka 160mm
 w wersji z moskitierą
 bez zabudowy

BC 16 I C

Covered 160mm
 box in insect screen version

Einbaurollladenkasten
 mit Insektenschutz 160mm

Skrzynka 160mm w wersji
 z moskitierą
 do zabudowy całkowitej



BeClever

BC 20 S

BC 20 S U

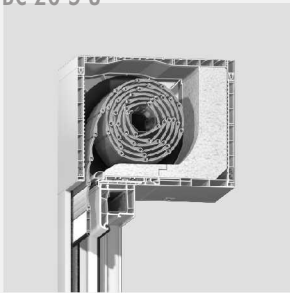

BC 20 S C(R)

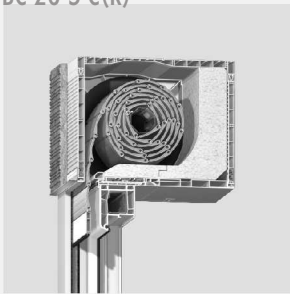

BC 20 S C(F)

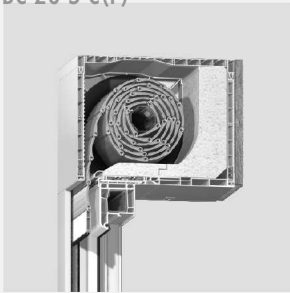

BC 20 S C

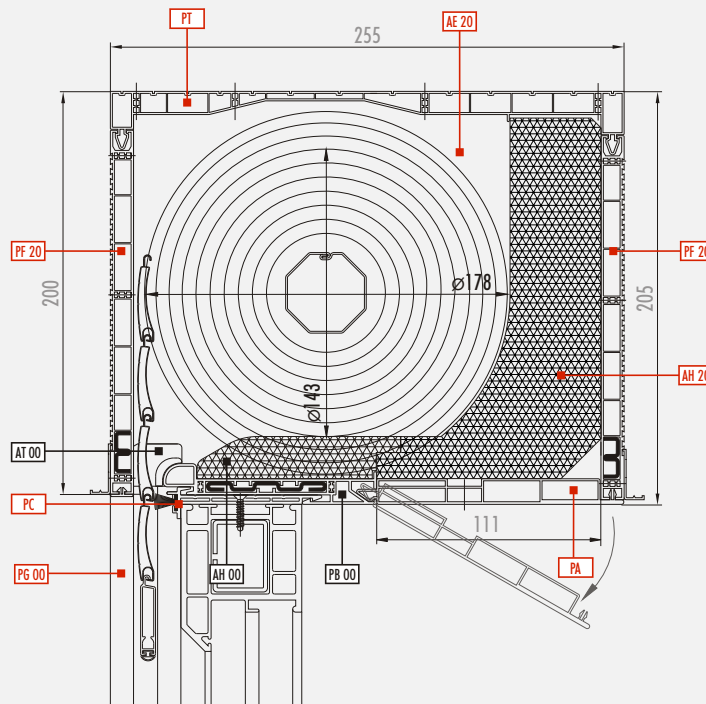
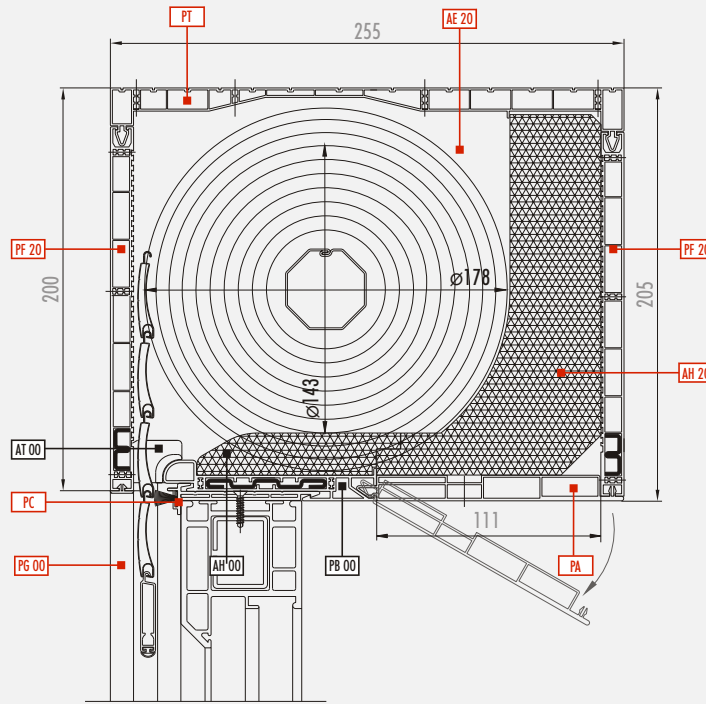
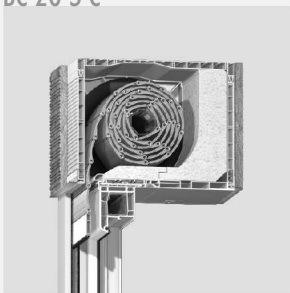

BC 20 S U

Uncovered 200mm
box in standard version

Standardrollladenkasten
200mm ohne Einbau

Skrzynka 200mm
w wersji standardowej
bez zabudowy

BC 20 S C

Covered 200mm
box in standard version

Standardeinbaurollladenkasten
200mm

Skrzynka 200mm
w wersji standardowej
do zabudowy całkowitej

one element - many applications
 ein Element - viele Verwendungsmöglichkeiten
 jeden element - viele zastosowań

BC 20 I

BC 20 I U

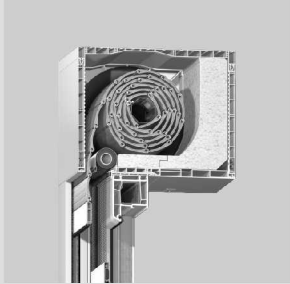

BC 20 I C(R)

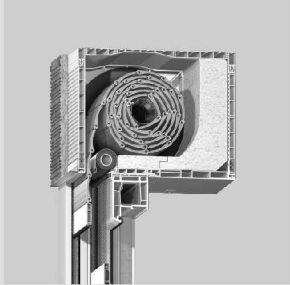

BC 20 I C(F)

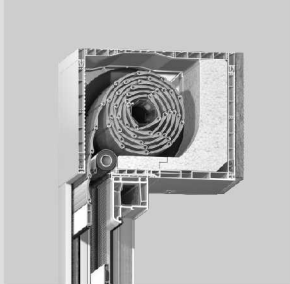

BC 20 I C

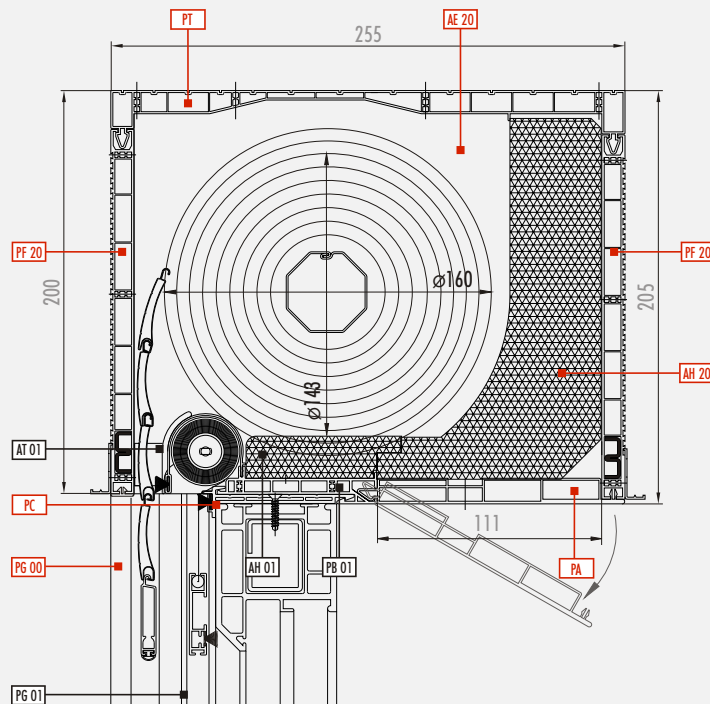
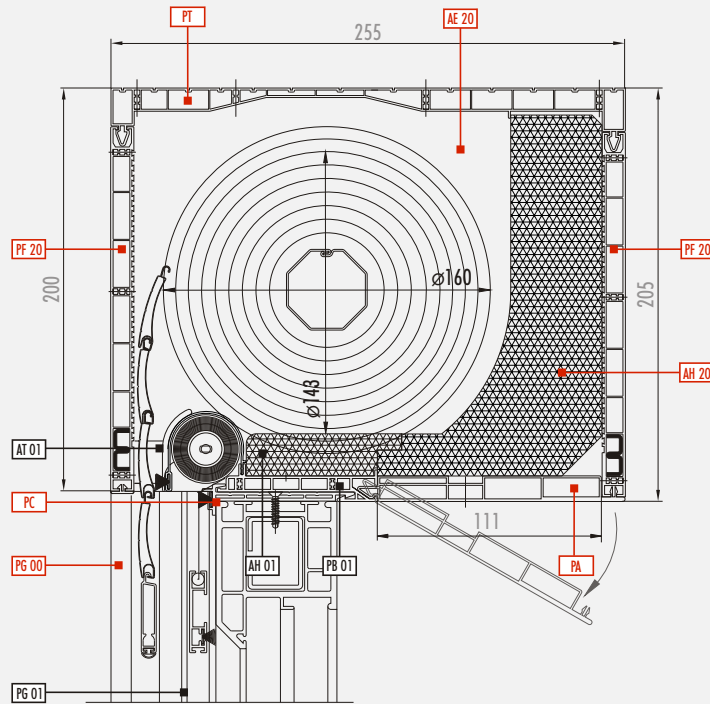
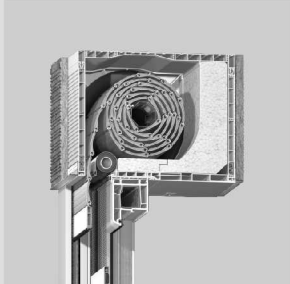

BC 20 I U

Uncovered 200mm
 box in insect screen version

Rollladenkasten 200mm
 mit Insektenschutz
 ohne Einbau

Skrzynka 200mm
 w wersji z moskitierą
 bez zabudowy

BC 20 I C

Covered 200mm
 box in insect
 screen version

Einbaurollladenkasten
 200mm
 mit Insektenschutz

Skrzynka 200mm
 w wersji z moskitierą
 do zabudowy całkowitej



BeClever

BC 24 S U



BC 24 S C(R)

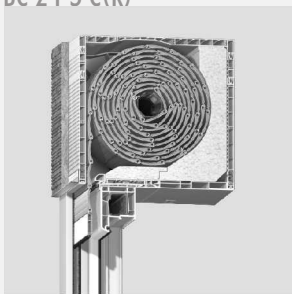

BC 24 S C(F)



BC 24 S C

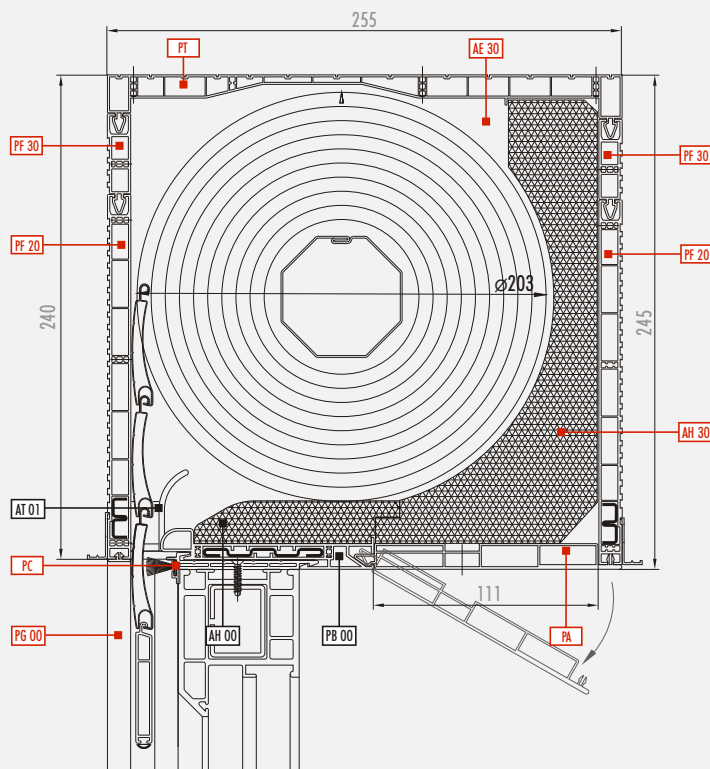
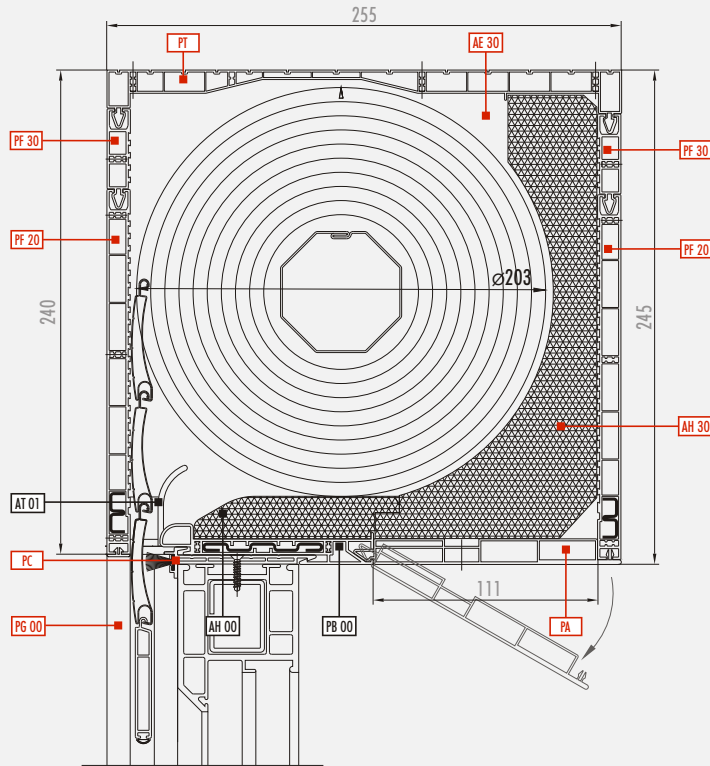
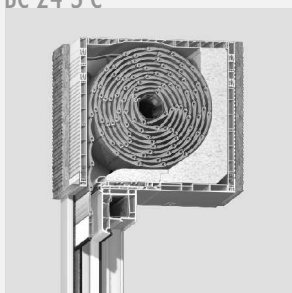

BC 24 S

BC 24 S U

Uncovered 240mm box in standard version

Standardrollladenkasten 240mm ohne Einbau

Skrzynka 240mm w wersji standardowej bez zabudowy

BC 24 S C

Covered 240mm box in standard version

Standardeinbaurollladenkasten 240mm

Skrzynka 240mm w wersji standardowej do zabudowy całkowitej

one element - many applications
 ein Element - viele Verwendungsmöglichkeiten
 jeden element - viele zastosowań

BC 24 I

BC 24 | U

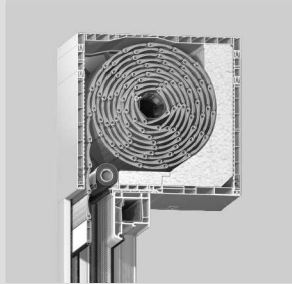

BC 24 | C(R)

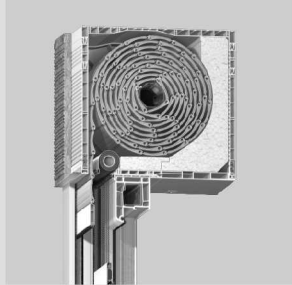

BC 24 | C(F)

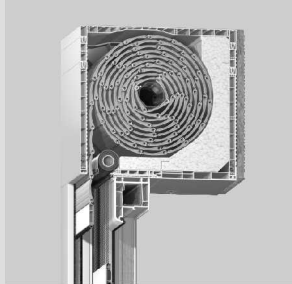

BC 24 | C

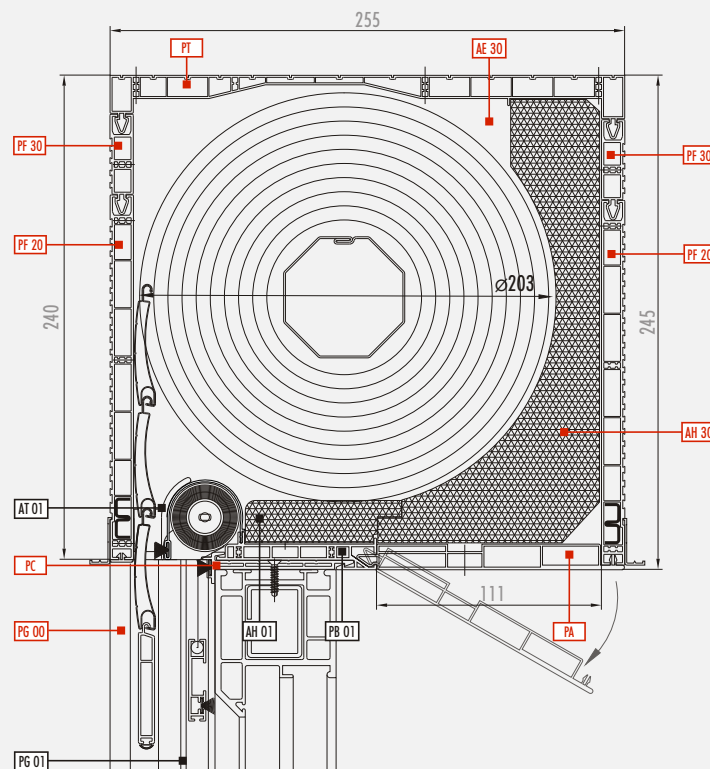
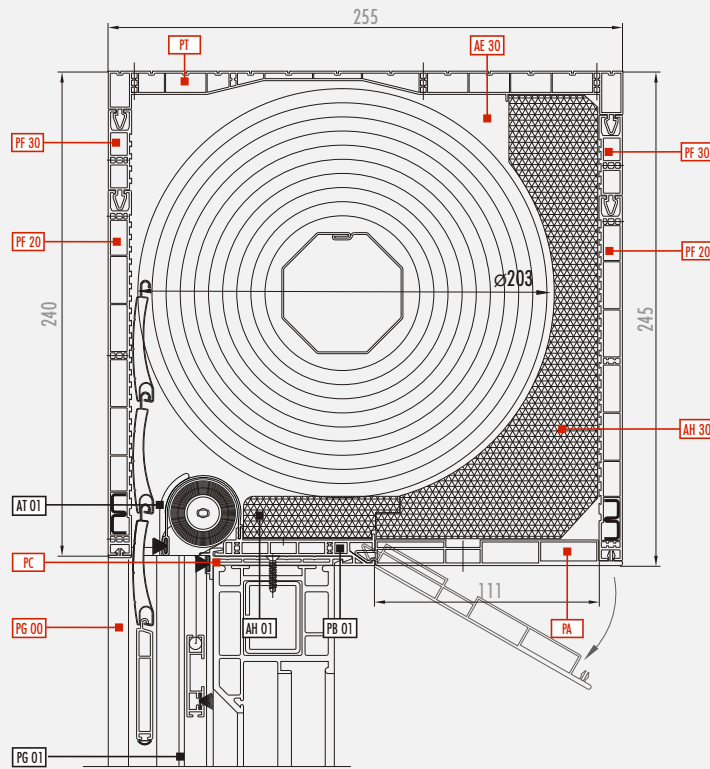
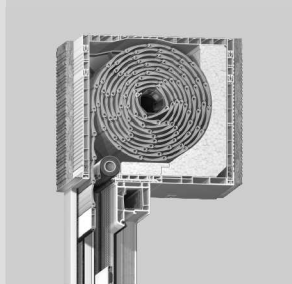

BC 24 | U

Uncovered 240mm
 box in insect screen version

Rollladenkasten 240mm
 mit Insektenschutz
 ohne Einbau

Skrzynka 240mm
 w wersji z moskitierą
 bez zabudowy

BC 24 | C

Covered 240mm
 box in insect
 screen version

Einbaurolladenkasten
 240mm mit Insektenschutz

Skrzynka 240mm
 w wersji z moskitierą
 do zabudowy całkowitej



BeClever

BC 16/20/24 S
BC 16/20/24 I

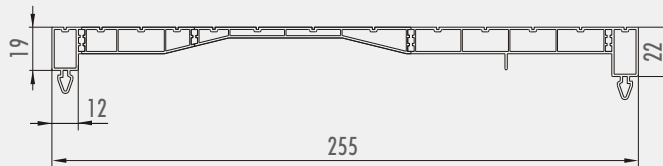

PT 00

01
02
XX
YY

box top profile
Kastenoberprofil
profil górny skrzynki

BC 16/20/24 S

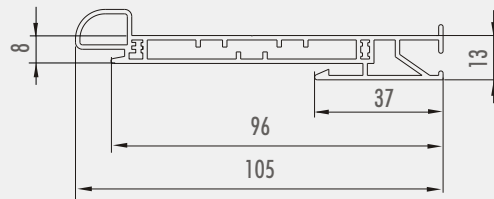

PB 00

01
XX
YY

box bottom profile
Kastenunterprofil
profil dolny skrzynki

BC 16/20/24 I

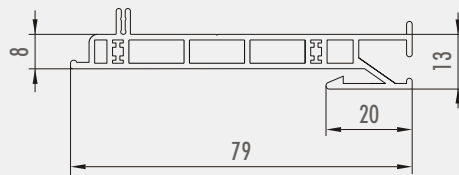

PB 01

01
XX
YY

insect screen box bottom profile
Kastenunterprofil mit Insektenschutz
profil dolny skrzynki z moskitierą

BC 16/20/24 S
BC 16/20/24 I

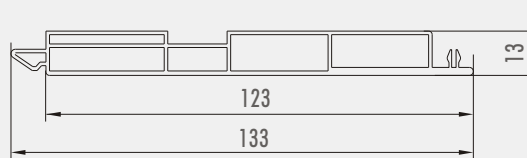

PA 00

01
XX
YY

box access plate
Kastenwartungsdeckel
pokrywa rewizyjna skrzynki

colours list - page 29
Farbpalette - Seite 29
paleta kolorów - strona 29

PS 00

BC 16/20/24 S

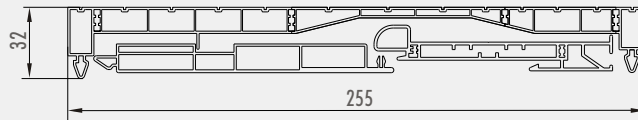

01

set PT 00 + PB 00 + PA 00
Kastenset PT 00 + PB 00 + PA 00
zestaw PT 00 + PB 00 + PA 00

PF 10

BC 16 S
BC 16 I

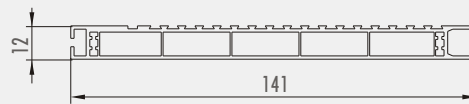

01

XX

YY

box BC16 front profile
Kastenvorderprofil BC16
profil czołowy skrzynki BC16

PF 20

BC 20/24 S
BC 20/24 I

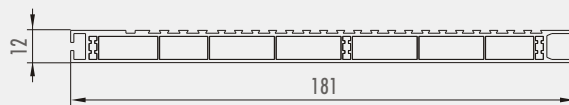

01

XX

YY

box BC20 front profile
Kastenvorderprofil BC20
profil czołowy skrzynki BC20

PF 30

BC 24 S
BC 24 I

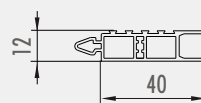

01

XX

YY

box BC24 front profile
Kastenvorderprofil BC24
profil czołowy skrzynki BC24



BeClever

BC 16/20/24 S
BC 16/20/24 I

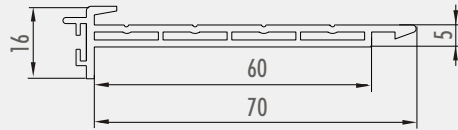

PC 00

01
02

box connection profile
Kastenadapterprofil
profil adaptacyjny skrzynki

BC 16/20/24 S
BC 16/20/24 I

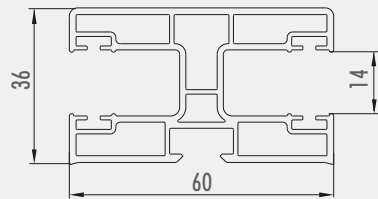

PG 00

01
XX
YY

curtain guide channel
Panzerführungsschiene
prowadnica pancerza

BC 16/20/24 I

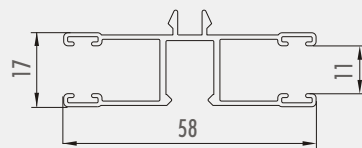

PG 01

00
01
02

insect screen guide channel
Insektenschutzführungsschiene
prowadnica siatki

BC 16 S
BC 16 I

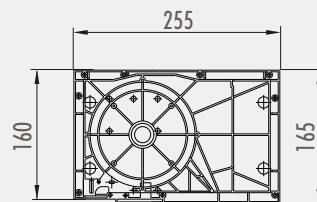

AE 10

01
02

box BC16 end piece
Kastenseitenkappe BC16
kapa boczna skrzynki BC16

colours list - page 29
Farbenpalette - Seite 29
paleta kolorów - strona 29

AE 20 --

BC 20 S
BC 20 I

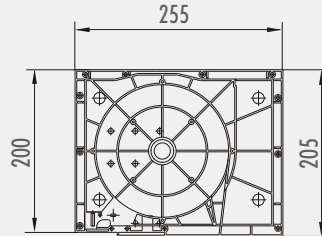

01
02

box BC20 end piece
Kastenseitenkappe BC20
kapa boczna skrzynki BC20

AE 30 --

BC 24 S
BC 24 I

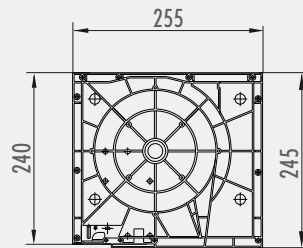

01
02

box BC24 end piece
Kastenseitenkappe BC24
kapa boczna skrzynki BC24

AC 10 --

BC 16 S
BC 16 I

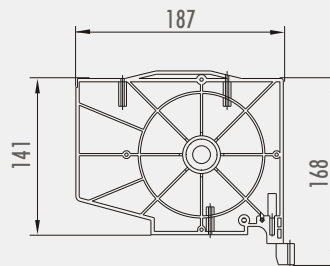

01

box BC16 central support
Teilungswand für Kasten BC16
ścianka podziałowa skrzynki BC16

AC 20 --

BC 20 S
BC 20 I

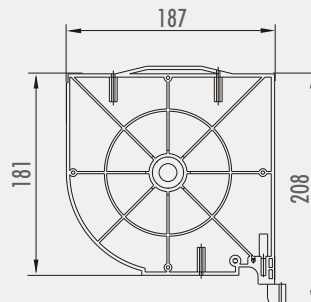

01

box BC20 central support
Teilungswand für Kasten BC20
ścianka podziałowa skrzynki BC20



BeClever

BC 24 S
BC 24 I

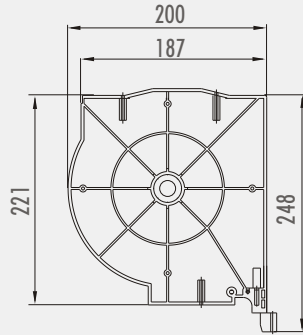

AC 30 --

01

box BC24 central support
Teilungswand für Kasten BC24
ścianka podziałowa skrzynki BC24

BC 16/20 S

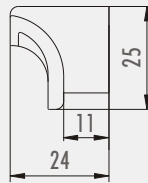

AT 00 --

01

02

mini terminal for AE and AC
Gleitführung mini für AE und AC
ślizg mini do AE i AC

BC 24 S
BC 16/20/24 I

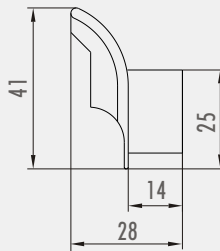

AT 01 --

01

02

maxi terminal for AE and AC
Gleitführung maxi für AE und AC
ślizg maxi do AE i AC

BC 16/20/24 S
BC 16/20/24 I

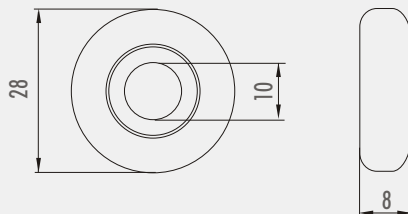

AB 00

ball bearing for AE and AC
Kugellager für AE und AC
łożysko kulkowe do AE i AC

AP 00

BC 16/20/24 S
BC 16/20/24 I

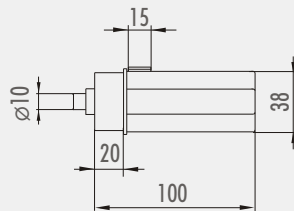

roller plug in 40mm shaft
Endstück für Welle 40mm
końcówka do wałka 40mm

AP 01

BC 16/20/24 S
BC 16/20/24 I

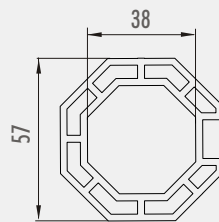

double roller plug in 40mm shaft
Doppelendstück für Welle 40mm
podwójna końcówka do wałka 40mm

AP 02

BC 16/20/24 S
BC 16/20/24 I

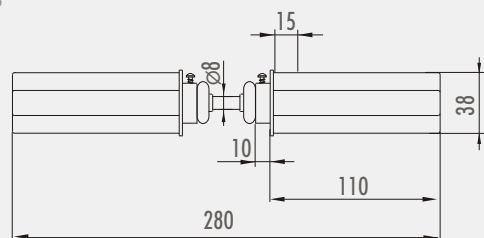

adapter ring from 40mm
to 60mm shaft
Adaptererring von der Welle
40mm auf 60mm
pierścień adaptacyjny z wałka
40mm na 60mm

AP 10

BC 16 S
BC 16 I

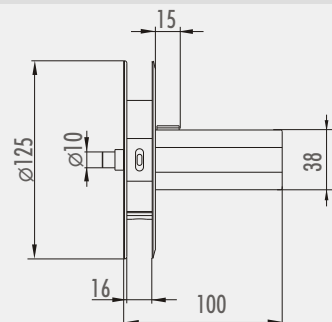

box BC16 tape pulley
for 40mm shaft
Wickelspule für den Kasten BC16
für die Welle 40mm
szpula nawojowa skrzynki BC16
do wałka 40mm



BeClever

BC 20/24 S
BC 20/24 I

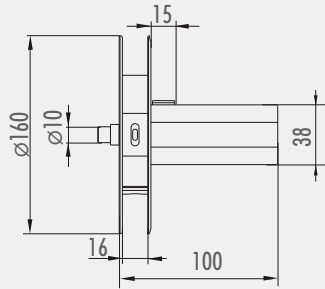

AP 20

box BC20 and BC24 tape pulley
for 40mm shaft
Wickelspule für die Kästen BC20 und BC24
für die Welle 40mm
szpula nawojowa skrzynki BC20 i BC24
do wałka 40mm

BC 16/20/24 S
BC 16/20/24 I

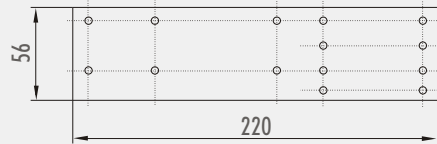

AF 00

box fixing strap for window frame
Kastenmontageset
für die Fensterrahmenmontage
mocowanie skrzynki do ramy okiennej

BC 16/20/24 S
BC 16/20/24 I

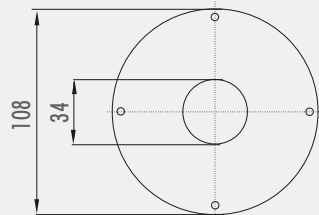

AM 00

motor mounting plate
Montageplatte für den Antrieb
płytkę montażową do napędów

BC 16/20/24 S
BC 16/20/24 I

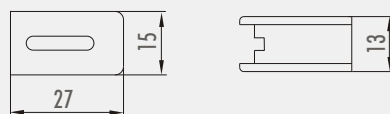

AG 00 --

01
02

tape guide
Gurtdurchführung
przelotka paska

colours list - page 29
Farbenpalette - Seite 29
paleta kolorów - strona 29

AU 00

BC 16/20/24 S
BC 16/20/24 I

01
02

cover for PF
Spaltblende für den PF
maskownica do PF

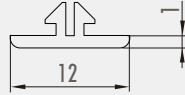

AA 00

BC 16/20/24 S
BC 16/20/24 I

00
01
02

angle profile
Winkelprofil
profil kątowy

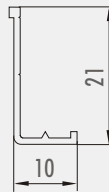

AR 01

BC 16/20/24 S
BC 16/20/24 I

reinforcement for PF
Verstärkung für den PF
wzmocnienie do PF

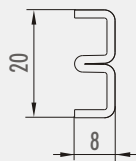

AR 02

BC 16/20/24 S

reinforcement for PB 00
Verstärkung für den PB 00
wzmocnienie do PB 00

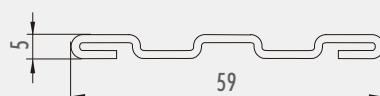



BeClever

BC 16/20 I

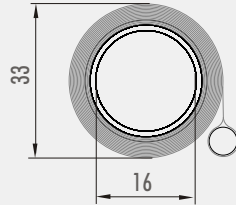

AN 01

insect screen 1700mm with shaft
Insektenschutzgitter 1700mm mit der Welle
siatka 1700mm z wałkiem

BC 20/24 I

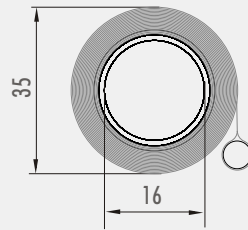

AN 02

insect screen 2500mm with shaft
Insektenschutzgitter 2500mm mit der Welle
siatka 2500mm z wałkiem

BC 16/20/24 I

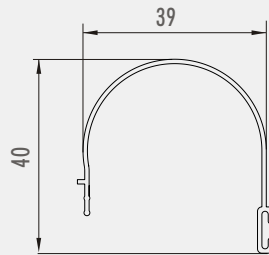

AW 00

wrapper for AN
Schutz für den AN
osłona do AN

BC 16/20/24 I

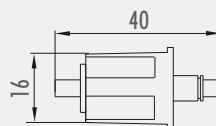

AD 00

roller plug for AN
Endstück für den AN
końcówka do AN

colours list - page 29
Farbenpalette - Seite 29
paleta kolorów - strona 29

AD 01

BC 16/20 I

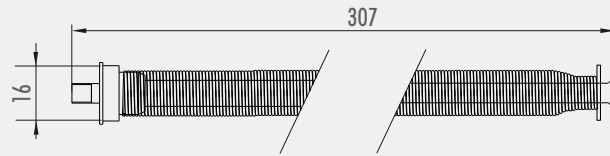

spring mechanics for AN 01
Federmechanismus für AN 01
mechanizm sprężynowy do AN 01

AD 02

BC 20/24 I

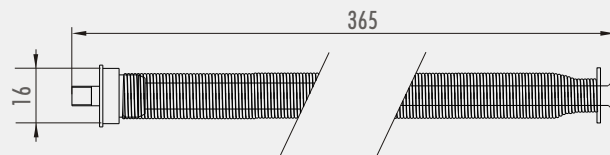

spring mechanics for AN 02
Federmechanismus für AN 02
mechanizm sprężynowy do AN 02

AZ 00 --

BC 16/20/24 I

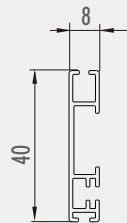

00
01
02

insect screen end slot
Gitterschlussleiste
listwa końcowa siatki

AL 01 --

BC 16/20/24 I

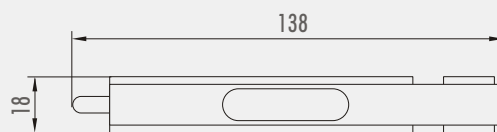

01
02

mini bolt for AZ
Riegel mini für den AZ
rygiel mini do AZ



BeClever

BC 16/20/24 I

AL 02

01
02

maxi bolt for AZ
Riegel maxi für den AZ
rygiel maxi do AZ

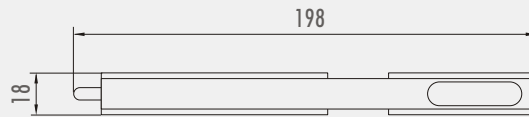

BC 16/20/24 I

AO 00

cord for AZ
Schnur für den AZ
sznurek do AZ

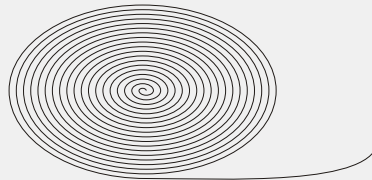

BC 16/20/24 I

AO 01

handle for AO 00
Griff für den AO 00
uchwyt do AO 00

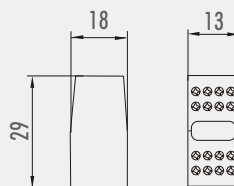

BC 16 S
BC 16 I

AH 10

box BC16 heat insulation
Kastenwärmedämmung BC16
ocieplenie skrzynki BC16

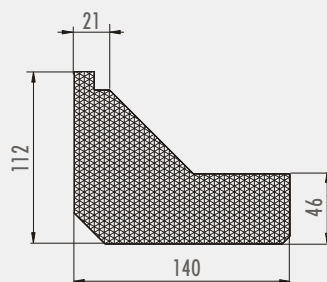

colours list - page 29
Farbenpalette - Seite 29
paleta kolorów - strona 29

AH 20

BC 20 S
BC 20 I

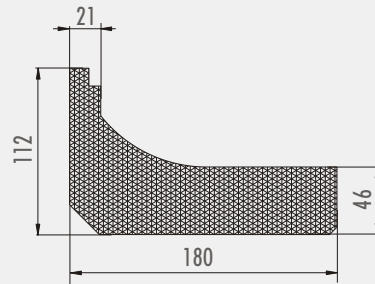

box BC20 heat insulation
Kastenwärmedämmung BC20
ocieplenie skrzynki BC20

AH 30

BC 24 S
BC 24 I

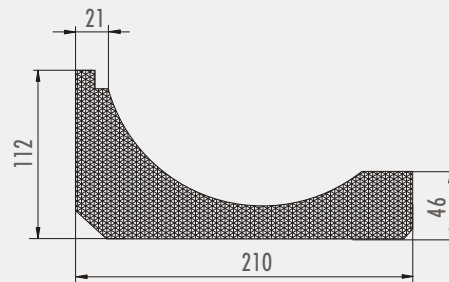

box BC24 heat insulation
Kastenwärmedämmung BC24
ocieplenie skrzynki BC24

AH 00

BC 16/20/24 S

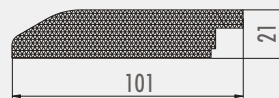

additional heat insulation
zusätzliche Kastenwärmedämmung
ocieplenie dodatkowe skrzynki

AH 01

BC 16/20/24 I

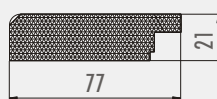

insect screen additional heat insulation
zusätzliche Kastenwärmedämmung
mit Insektenschutz
ocieplenie dodatkowe skrzynki
z moskitierq



BeClever

BC 16/20/24 S
BC 16/20/24 I

AS 01

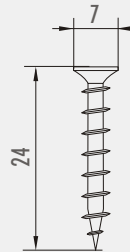

box mounting screw
Kastenmontageschraube
wkręt montażowy skrzynki

AS 02

BC 16/20/24 S
BC 16/20/24 I

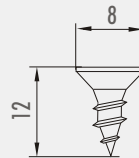

mounting screw for AF and AM
Montageschraube für AF und AM
wkręt montażowy do AF i AM

AS 03

BC 16/20/24 S
BC 16/20/24 I

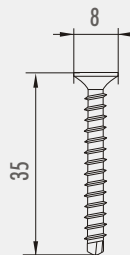

mounting screw for PC
Montageschraube für PC
wkręt montażowy do PC

AS 04

BC 16/20/24 S

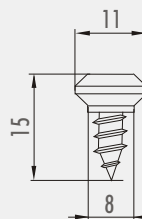

mounting screw for PG 00
Montageschraube für PG 00
wkręt montażowy do PG 00

AS 05

BC 16/20/24 S
BC 16/20/24 I

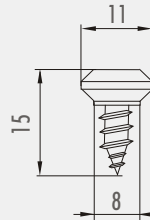

mounting screw for PG 00 and PG 01
Montageschraube für die
Führungsschienen PG 00 und PG 01
wkreł montażowy do prowadnic
PG 00 i PG 01

AI 01

BC 16/20/24 S
BC 16/20/24 I

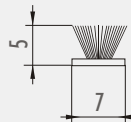

5mm brush insert for PG 00, PG 01
and PC
5mm Bürstendichtung für PG 00, PG 01
und PC
uszczelka szczotkowa 5mm
do PG 00, PG 01 i PC

AI 02

BC 16/20/24 S
BC 16/20/24 I

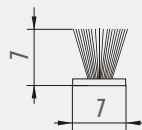

7mm brush insert for PG 00
7mm Bürstendichtung für PG 00
uszczelka szczotkowa 7mm do PG 00

AI 03

BC 16/20/24 S
BC 16/20/24 I

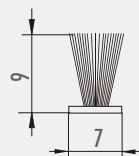

9mm brush insert for PG 00, AW
and AZ
9mm Bürstendichtung für PG 00, AW
und AZ
uszczelka szczotkowa 9mm
do PG 00, AW i AZ



BeClever

BC 16/20/24 S

AI 04

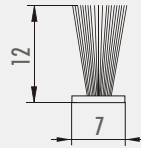

12mm brush insert for PC
12mm Bürstendichtung für PC
uszczelka szczotkowa 12mm do PC

AI 05

BC 16/20/24 S
BC 16/20/24 I

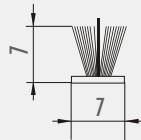

7mm brush insert with stabilizer
for PG 00
7mm Bürstendichtung mit Stabilisator
für PG 00
uszczelka szczotkowa ze stabilizatorem
7mm do PG 00

AI 06

BC 16/20/24 S
BC 16/20/24 I

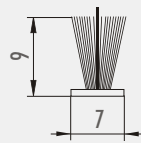

9mm brush insert with stabilizer for PG 00
9mm Bürstendichtung mit Stabilisator
für PG 00
uszczelka szczotkowa ze stabilizatorem
9mm do PG 00

colours list
Farbenpalette
paleta kolorów

-- colour Farbe kolor

00	mill-finished	blank	surowy
01	white	weiss	biały
02	brown	braun	brązowy

-- standard foil colour standarde Dekorfolie okleina standardowa Renolit

XX	04	mahogany	Mahagoni	mahoń	2065021
	05	hazelnut	Nuß	orzech	2178007
	06	marsh oak	Mooreiche	dąb bagienny	2052089
	07	golden oak	Goldeiche	dąb złoty	2178001
	20	chocobrown	Schokobraun	czekoladowy	1887505
	21	palisander	Palisander	palisander	1851805

-- unstandard foil colour unstandarde Dekorfolie okleina niestandardowa Renolit

YY	08	natural oak	Natureiche	dąb naturalny	3118076
	09	light oak	Leichteiche	dąb jasny	3167002
	10	dark oak	Dunkeleiche	dąb ciemny	3167004
	11	douglas	Douglas	dagleźja	3152009
	12	mountain pine	Bergkiefer	sosna góraska	3069041
	13	grey	Grau	szary	1715505
	14	anthracite grey	Anthrazitgrau	antracytowy szary	1701605
	16	steel blue	Stahlblau	stalowy niebieski	1515005
	17	dark red	Dunkelrot	ciemny czerwony	1308105
	18	moss green	Moosgrün	zielony	1600505
	19	dark green	Dunkelgrün	ciemny zielony	1612505



BeClever

BC 16 S $U_{si}=0,85 \text{ W}/(\text{M}^2 \cdot \text{K})$
 $f_{Rsi}=0,70$

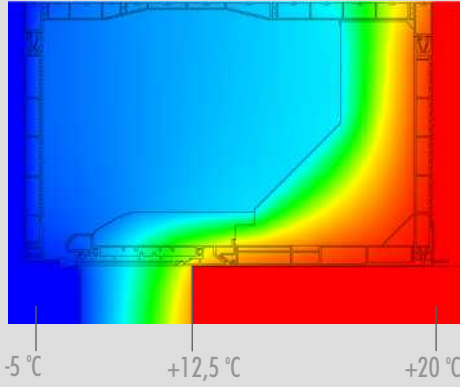

BC 16 I $U_{si}=0,82 \text{ W}/(\text{M}^2 \cdot \text{K})$
 $f_{Rsi}=0,70$

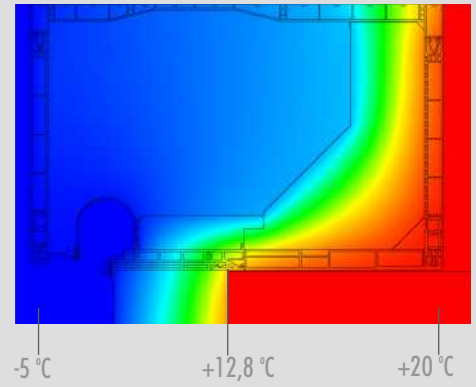

BC 20 S $U_{si}=0,83 \text{ W}/(\text{M}^2 \cdot \text{K})$
 $f_{Rsi}=0,70$

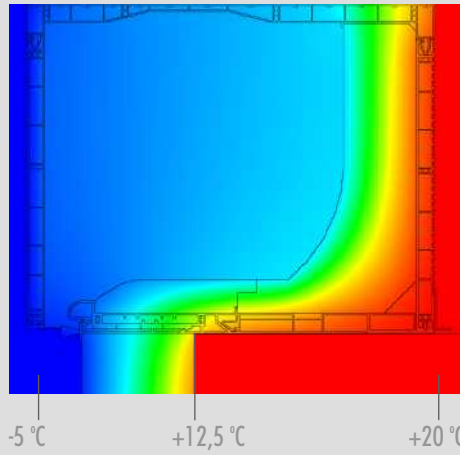

BC 20 I $U_{si}=0,83 \text{ W}/(\text{M}^2 \cdot \text{K})$
 $f_{Rsi}=0,70$

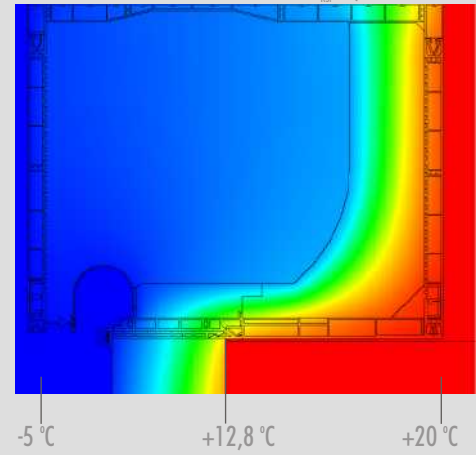

BC 24 S $U_{si}=0,85 \text{ W}/(\text{M}^2 \cdot \text{K})$
 $f_{Rsi}=0,70$

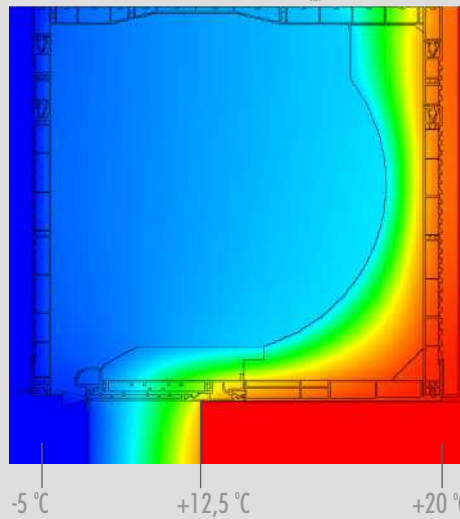

BC 24 I $U_{si}=0,85 \text{ W}/(\text{M}^2 \cdot \text{K})$
 $f_{Rsi}=0,71$

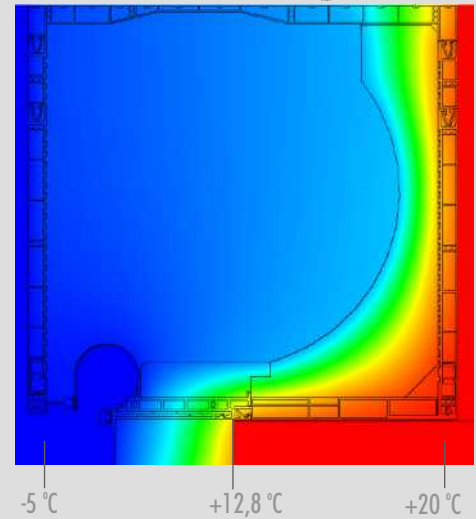

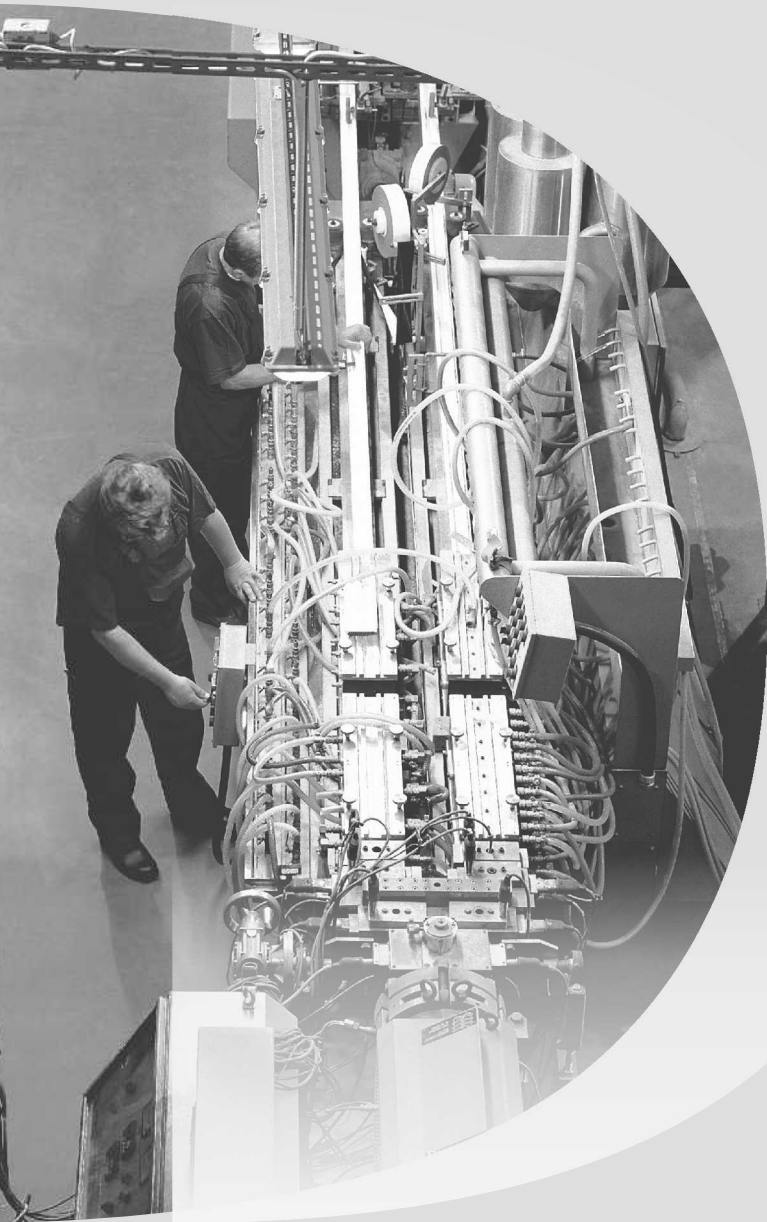

BeClever Sp. z o.o., Polska, 62-300 Września, ul. Malinowa 1
tel. +48 61 4360 354, fax +48 61 4360 357, e-mail: info@beclever.eu

www.beclever.eu